

Foundation Series

LUXURY GAS FIREPLACES



HEAT & GLO

No one builds a better fire

I believe that architecture is an art.
To become art it must be built on
a foundation of necessity.

— I. M. PEI, Architect

Foundation Series

TABLE OF CONTENTS

About Foundation Series.....	3
Features and Options.....	3
Single-Sided.....	4
See-Through.....	6
Pier.....	8
Bay.....	10
Glass, Stone and LED lights.....	12
Technologies.....	14



A Showpiece Fireplace with a Captivating Presence

Modern in form and luxurious by design, the Foundation Series was created with consideration for the whole space, bringing your vision together. Inspired by key architecture and design principals and then carefully honed to simplicity with clean lines and functional shapes, Foundation Series features are embraced by the most discerning homeowners and builders.

With big, bold flames that elevate your senses and a clear view of the beautiful fire, the Foundation Series adds a signature focal point to today's most sophisticated interiors.

Features and Options

STANDARD FEATURES

- All models are UL listed
- Patented SafeSurface™ double-pane glass - proprietary cooling system keeps heat away from outer glass surface with no safety screen needed
- Clean finish with combustible materials right up to the fireplace opening
- Black interior
- Ribbon burner - 20,000 BTUs per linear foot provides big flame appearance
- Remote control allows you to select a variety of colored LED chromotherapy lighting
- Crystal glass media
- On/Off wall switch

OPTIONS

- Three additional colors of glass media (Ebony, Amber and Caribbean Blue)
- Three options of real natural stones (Mixed, Polished Gold, Polished Black)
- Driftwood log set for each size
- Reversible mirrored interior panels for enhanced or subtle infinite flame reflection
- Can be connected to smart home automation systems*

*Contact your home automation expert for information specific to your home.

Single-Sided

Even your most timeless setting comes alive with a Foundation Series single-sided luxury fireplace, where innovative appearance meets modern design.

MODEL	FRONT WIDTH (A)		BACK WIDTH (B)		HEIGHT (C)		DEPTH (D)		GLASS SIZE (E x F)
	Actual	Framing	Actual	Framing	Actual	Framing	Actual	Framing	
FDN-4-SS	53-3/4" [1,365]	55-3/4" [1,416]	53-3/4" [1,365]	55-3/4" [1,416]	50" [1,270]	56" [1,422]	24-1/32" [610]	25-1/32" [636]	50-3/16" x 24" [1,275 x 610]
FDN-5-SS	65-3/4" [1,670]	67-3/4" [1,721]	65-3/4" [1,670]	67-3/4" [1,721]	50" [1,270]	56" [1,422]	24-1/32" [610]	25-1/32" [636]	62-3/16" x 24" [1,580 x 610]
FDN-6-SS	77-3/4" [1,975]	79-3/4" [2,026]	77-3/4" [1,975]	79-3/4" [2,026]	50" [1,270]	56" [1,422]	24-1/32" [610]	25-1/32" [636]	74-3/16" x 24" [1,884 x 610]
FDN-7-SS	89-3/4" [2,280]	91-3/4" [2,330]	89-3/4" [2,280]	91-3/4" [2,330]	50" [1,270]	56" [1,422]	24-1/32" [610]	25-1/32" [636]	86-3/16" x 24" [2,189 x 610]

Left View

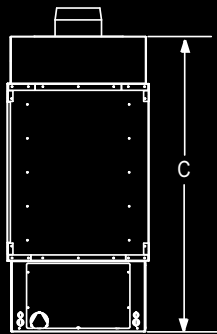

Front View

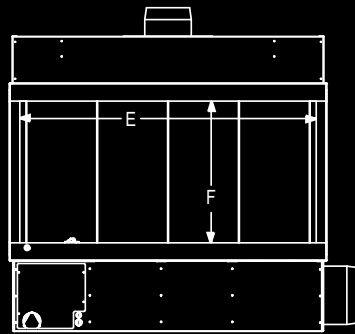

Top View

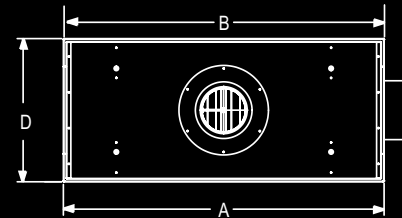

Right View

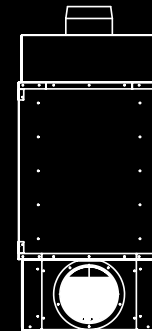



See-Through

Add a spacious new dimension to your living space or gathering area with a Foundation Series luxury see-through fireplace. It's a captivating look that invites conversation.

MODEL	FRONT WIDTH (A)		BACK WIDTH (B)		HEIGHT (C)		DEPTH (D)		GLASS SIZE (E x F)
	Actual	Framing	Actual	Framing	Actual	Framing	Actual	Framing	
FDN-4-ST	53-3/4" [1,365]	55-3/4" [1,416]	53-3/4" [1,365]	55-3/4" [1,416]	50" [1,270]	56" [1,422]	24" [610]	23" [584]	50-3/16" x 24" [1,275 x 610]
FDN-5-ST	65-3/4" [1,670]	67-3/4" [1,721]	65-3/4" [1,670]	67-3/4" [1,721]	50" [1,270]	56" [1,422]	24" [610]	23" [584]	62-3/16" x 24" [1,580 x 610]
FDN-6-ST	77-3/4" [1,975]	79-3/4" [2,026]	77-3/4" [1,975]	79-3/4" [2,026]	50" [1,270]	56" [1,422]	24" [610]	23" [584]	74-3/16" x 24" [1,884 x 610]
FDN-7-ST	89-3/4" [2,280]	91-3/4" [2,330]	89-3/4" [2,280]	91-3/4" [2,330]	50" [1,270]	56" [1,422]	24" [610]	23" [584]	86-3/16" x 24" [2,189 x 610]

Left View

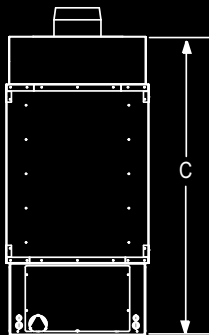

Front View

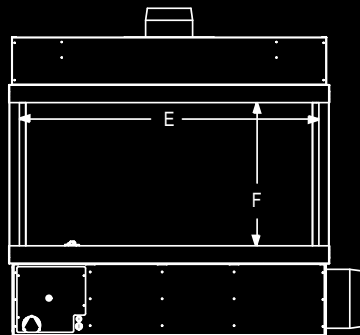

Top View

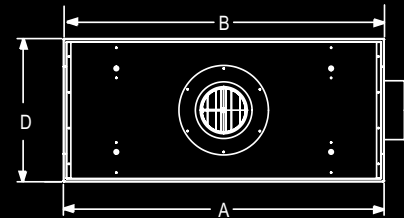

Right View

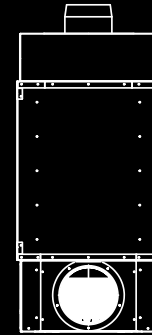



Pier

Let your distinctive spaces maintain their own character while you tastefully unite your overall design. A Foundations Series pier fireplace brings your interior together.

MODEL	FRONT WIDTH (A)		BACK WIDTH (B)		HEIGHT (C)		DEPTH (D)		GLASS SIZE LONG SIDE (E x F)	GLASS SIZE SHORT SIDE (G x F)
	Actual	Framing	Actual	Framing	Actual	Framing	Actual	Framing		
FDN-4-PIER	53-3/4" [1,365]	54-3/4" [1,391]	53-3/4" [1,365]	54-3/4" [1,391]	50" [1,270]	56" [1,422]	24" [610]	23" [584]	50-13/16" x 24" [1,290 x 610]	24" x 24" [610 x 610]
FDN-5-PIER	65-3/4" [1,670]	66-3/4" [1,695]	65-3/4" [1,670]	66-3/4" [1,695]	50" [1,270]	56" [1,422]	24" [610]	23" [584]	62-13/16" x 24" [1,595 x 610]	24" x 24" [610 x 610]
FDN-6-PIER	77-3/4" [1,975]	78-3/4" [2,000]	77-3/4" [1,975]	78-3/4" [2,000]	50" [1,270]	56" [1,422]	24" [610]	23" [584]	74-13/16" x 24" [1,900 x 610]	24" x 24" [610 x 610]
FDN-7-PIER	89-3/4" [2,280]	90-3/4" [2,305]	89-3/4" [2,280]	90-3/4" [2,305]	50" [1,270]	56" [1,422]	24" [610]	23" [584]	86-13/16" x 24" [2,205 x 610]	24" x 24" [610 x 610]

Left View

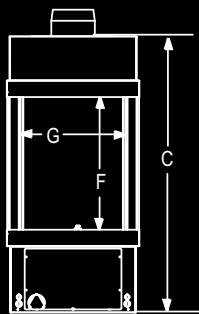

Front View

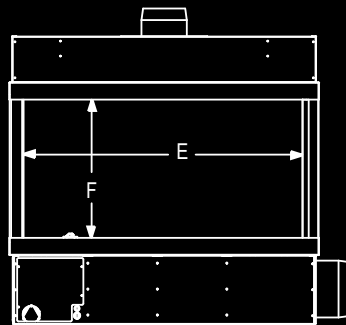

Top View

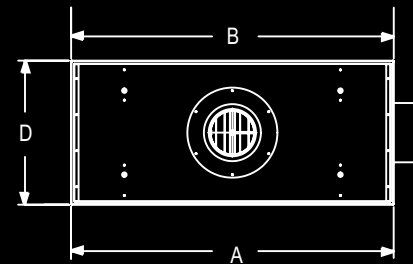

Right View

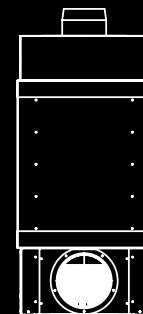



Bay

Trend-defining innovation embraces multi-sided visual enjoyment in a Foundation Series bay fireplace, where first glances become lasting looks—from every vantage point.

MODEL	FRONT WIDTH (A)		BACK WIDTH (B)		HEIGHT (C)		DEPTH (D)		GLASS SIZE LONG SIDE (E x F)	GLASS SIZE SHORT SIDE (G x F)
	Actual	Framing	Actual	Framing	Actual	Framing	Actual	Framing		
FDN-4-BAY	53-3/4" [1,365]	52-3/4" [1,340]	53-3/4" [1,365]	52-3/4" [1,340]	50" [1,270]	56" [1,422]	24" [610]	25" [635]	53-5/8" x 24" [1,362 x 610]	24" x 24" [610 x 610]
FDN-5-BAY	65-3/4" [1,670]	64-3/4" [1,645]	65-3/4" [1,670]	64-3/4" [1,645]	50" [1,270]	56" [1,422]	24" [610]	25" [635]	65-5/8" x 24" [1,667 x 610]	24" x 24" [610 x 610]
FDN-6-BAY	77-3/4" [1,975]	76-3/4" [1,949]	77-3/4" [1,975]	76-3/4" [1,949]	50" [1,270]	56" [1,422]	24" [610]	25" [635]	77-5/8" x 24" [1,972 x 610]	24" x 24" [610 x 610]
FDN-7-BAY	89-3/4" [2,280]	88-3/4" [2,254]	89-3/4" [2,280]	88-3/4" [2,254]	50" [1,270]	56" [1,422]	24" [610]	25" [635]	89-5/8" x 24" [2,276 x 610]	24" x 24" [610 x 610]

Left View

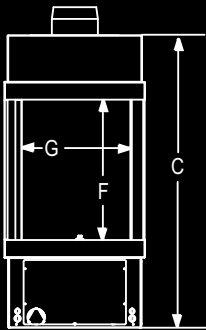

Front View

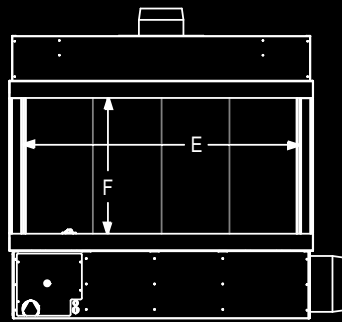

Top View

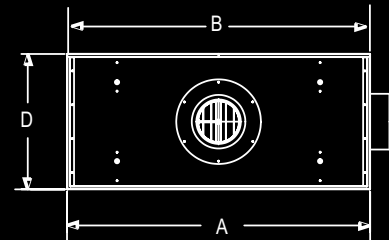

Right View

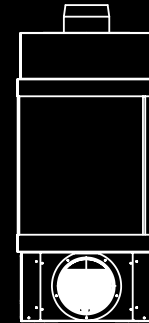



OPTIONAL GLASS MEDIA, REAL NATURAL STONES, DRIFTWOOD LOGS AND MIRRORED INTERIOR PANELS

Personalize your fireplace with many different options.

GLASS MEDIA



CRYSTAL (STANDARD)



AMBER



CARIBBEAN BLUE



EBONY

REAL NATURAL STONES



High Polished Black



Polished Mixed



Polished Gold

DRIFTWOOD LOGS



REVERSIBLE MIRRORED INTERIOR PANELS



Enhanced infinite flame reflection or subtle infinite flame reflection

REMOTE CONTROL

Each Foundation Series fireplace comes standard with multi-colored chromotherapy LED lighting and remote control. Set and easily change the lights to different hues to match whatever mood or color scheme you'd like. Chromotherapy uses light in the form of color to balance energy in a person's body by enhancing relaxation or invigoration.





TECHNOLOGIES

The Foundation Series includes commercial grade valve and ignition system for your peace of mind. Flexible vent runs (up to 110', 11 elbows, 6' vertical drop) give you ultimate design versatility.



CO-LINEAR DIRECT VENT WITH POWERVENT SYSTEM

Co-linear design utilizing B-vent with choice of standard external power vent or inline power vent exhaust system, which allows for installation flexibility.

MODEL	FLUE	OUTSIDE AIR
4'	8"	10"
5'	8"	10"
6'	10"	10"
7'	10"	10"



SAFE SURFACE GLASS

Patented SafeSurface double-pane glass - proprietary cooling system keeps heat away from outer glass surface with no safety screen needed.



STANDARD MECHANICAL INTAKE DAMPER

Keeps cold air out; reversible collar allows air to come in from the side or bottom of fireplace.

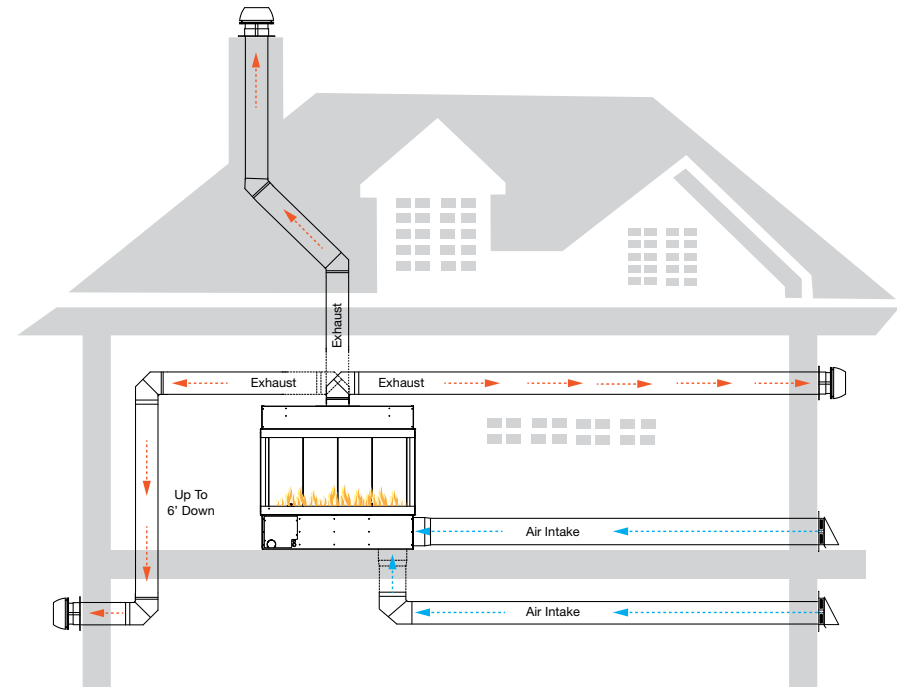

Foundation Series fireplaces vent off the top of the unit. Whether the desired cap location is a vertical or side wall application, you have up to 110 feet and 11 elbows to plan your vent run allowing the fireplace to be right where you want it.

FINISHING GUIDELINES

FLEXIBILITY TO CREATE THE LOOK YOU WANT

How you finish the wall around the fireplace will increase its impact on the space and reflect your personal style. Whether your taste is more subtle or you prefer the simplistic details of a clean modern look, the Foundation Series was designed with minimal clearances to combustible finishing materials so you can get as creative as you'd like.

Combustible finishing materials may cover this area right up to the fireplace opening. Note: Never overlap glass with any of the finishing materials.

Placement of optional combustible or non-combustible mantel and/or hearth may be up to the fireplace opening.

Four control access locations are provided on every fireplace for easy installation and service.

Access with a removable panel in your finishing materials in one of three locations on the fireplace. For a truly clean look, you can cover them all up and gain access from the interior of the firebox.

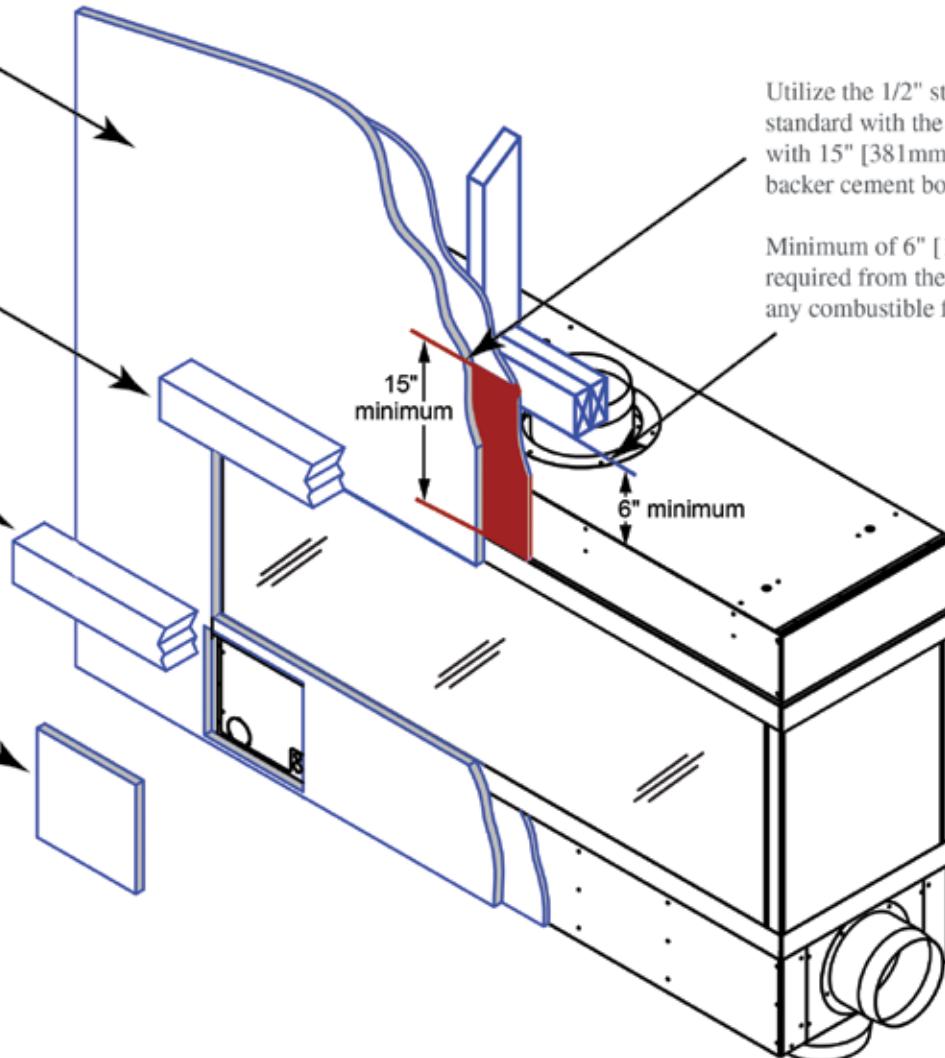

Utilize the 1/2" stand-offs that ship standard with the fireplace or replace with 15" [381mm] non-combustible backer cement board must be in this area.

Minimum of 6" [152mm] clearance required from the top of the fireplace to any combustible framing.

15" minimum

6" minimum

For complete information on this model, please contact us at:

HEAT & GLO

No one builds a better fire

For Professionals: pro.heatnglo.com

For Consumers:
heatnglo.com
(888) 427-3973
info@heatnglo.com

 facebook.com/HeatandGlo

 twitter.com/HeatandGlo

 youtube.com/HeatandGlo

 instagram.com/HeatandGlo

LIMITED LIFETIME WARRANTY¹

The strongest in the industry, Heat & Glo provides a limited lifetime warranty on the most important aspects: firebox and heat exchanger.

¹: For full warranty details see heatnglo.com
Fireplace glass and other surfaces get extremely HOT and can cause severe burns if touched. Keep a safe distance away. To learn more visit www.heatnglo.com/ fireplace safety.

HNG-1162-0419

