

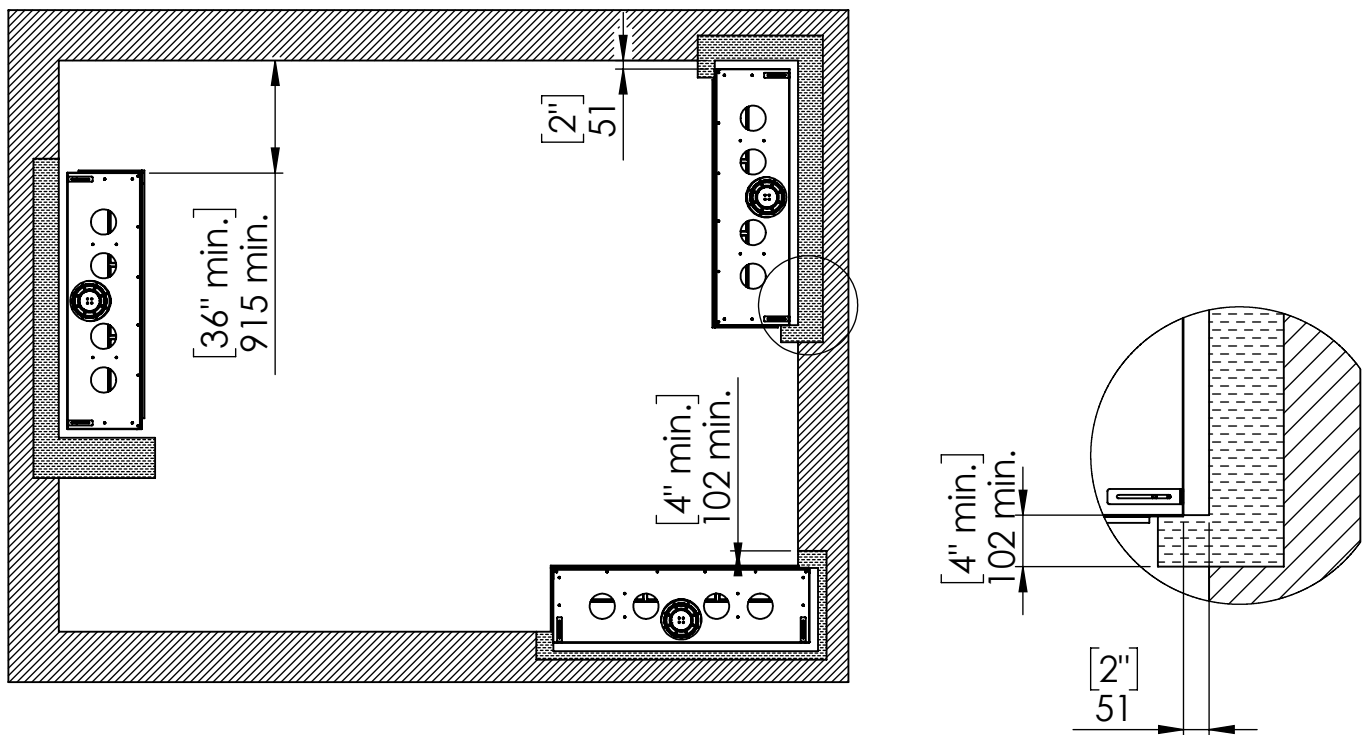

Specifications for Appliance Flare Right Corner 100

Factor	NG	LPG
Burner Type	55,105,55	55,105,55
Orifice	550,1200,550	180,260,180
BTU Max.	60000	60000
BTU min.	32500	25500
Kw/h	17.5k	17.5k
Chimney DIA.	5X8	5X8
Manifold Pressure[w.c]	4.4	7.4
Efficiency rate	81	76
Glass Size Length\Width	2520.5 X 423 mm	99" 1/4 X 16" 9/16'
Appliance Weigh	270Kg	595lb

Appliance Location



 Combustible Materials
 Non Combustible Materials

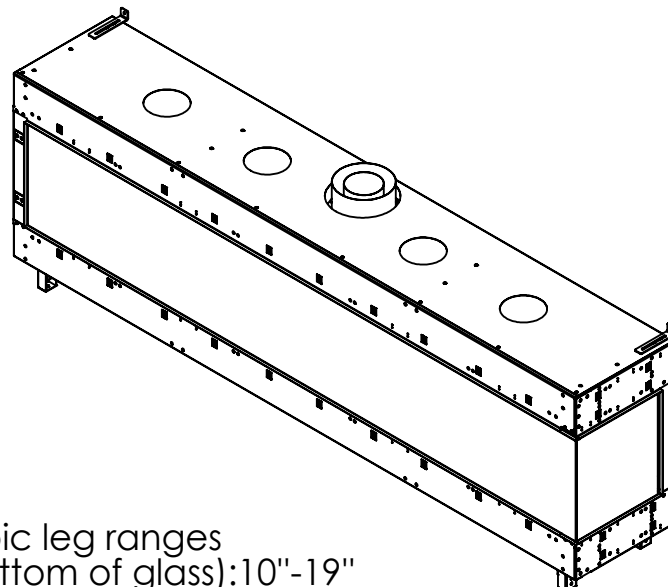
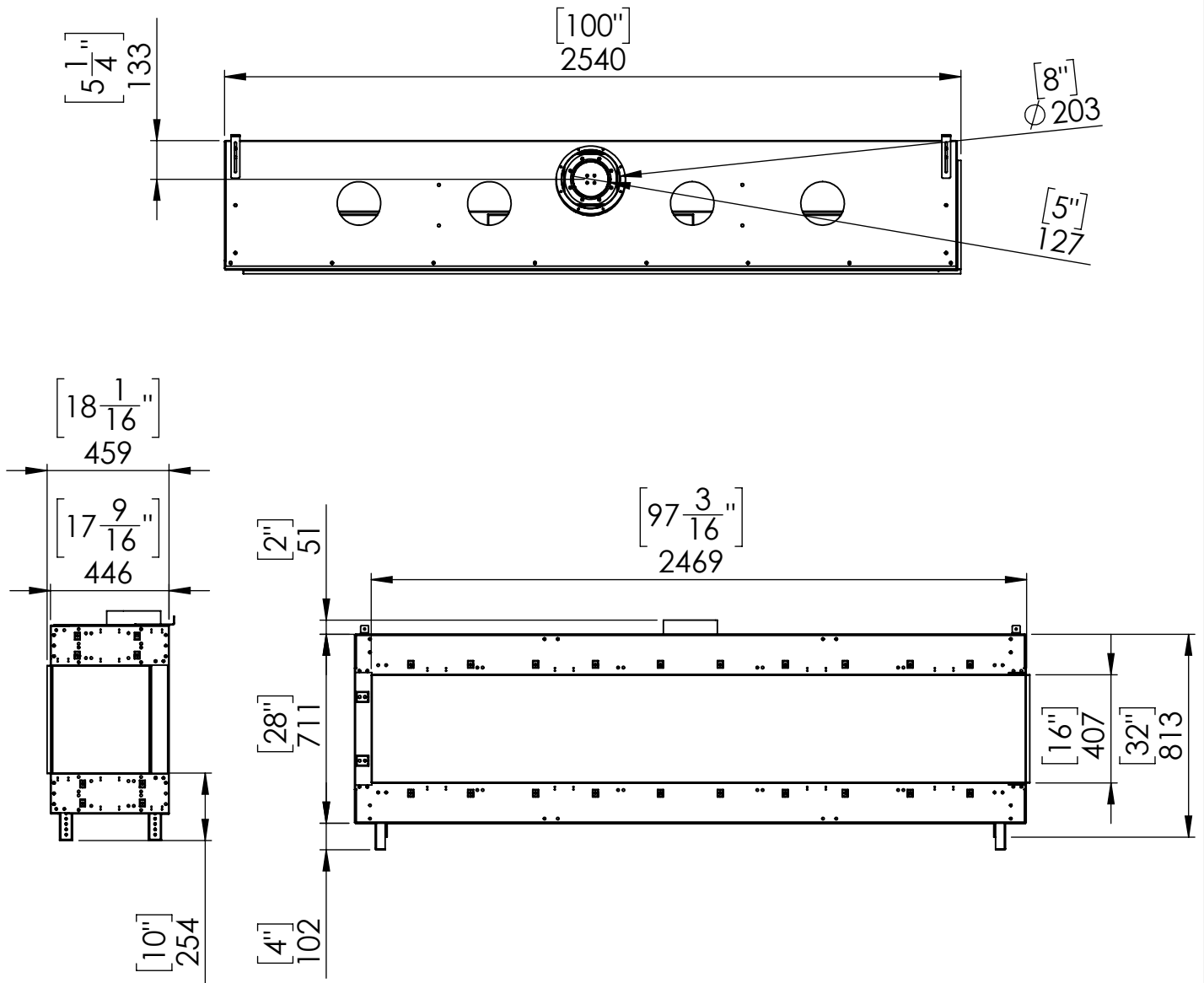

Telescopic leg ranges
(from bottom of glass): 10"-19"

Flat Installation

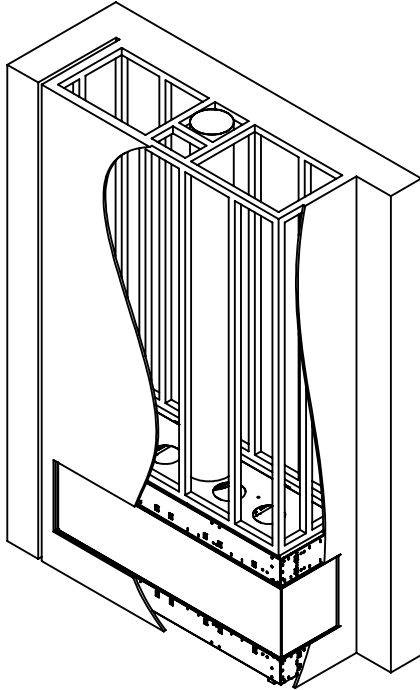

Recess Installation

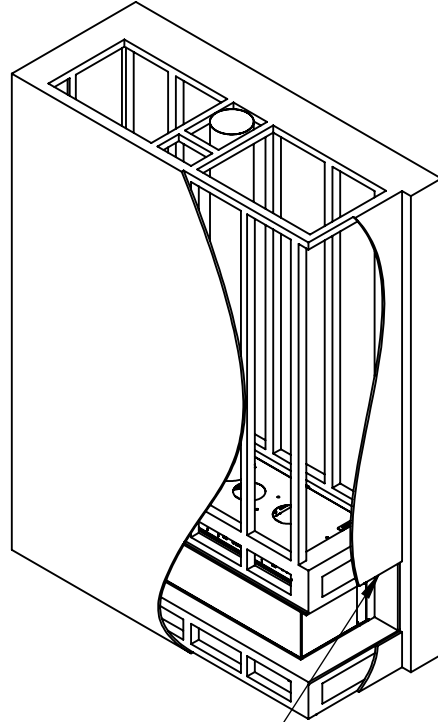

Top of Recess
4" max

Step 1 - Basic Framing :

Step 1 - Basic Framing :

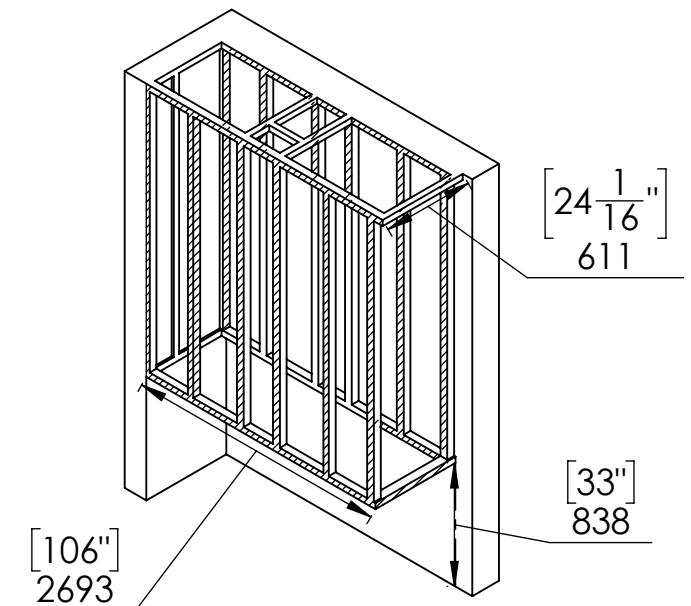
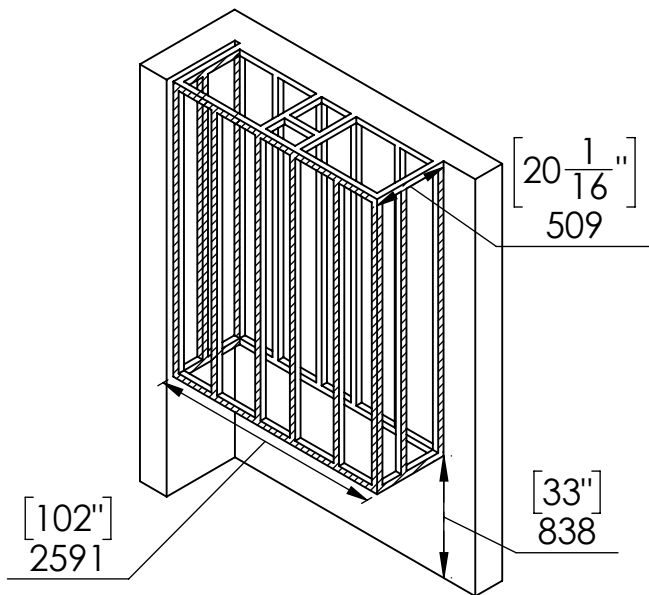

 Metal Stud

 Metal Stud

Flat Installation

Step 2 -Positioning the Fireplace:

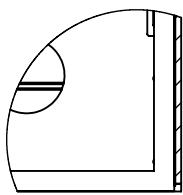
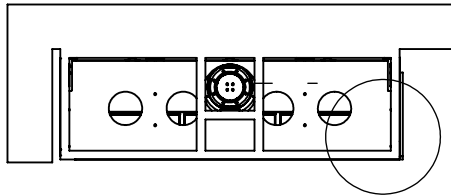

Fireplace frame finishing holder space to match wall finishing thickness

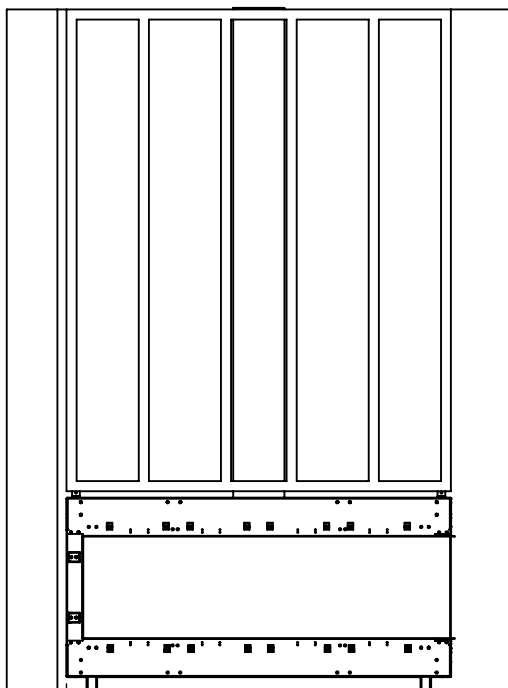

$2\frac{1}{2}"$
63

Recess Installation

Step 2 -Positioning the Fireplace:

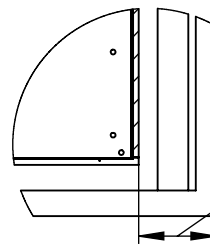
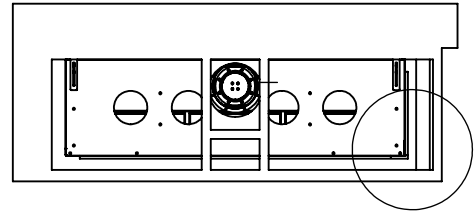

$4"$ gap to match the max. length of top shelf.
102

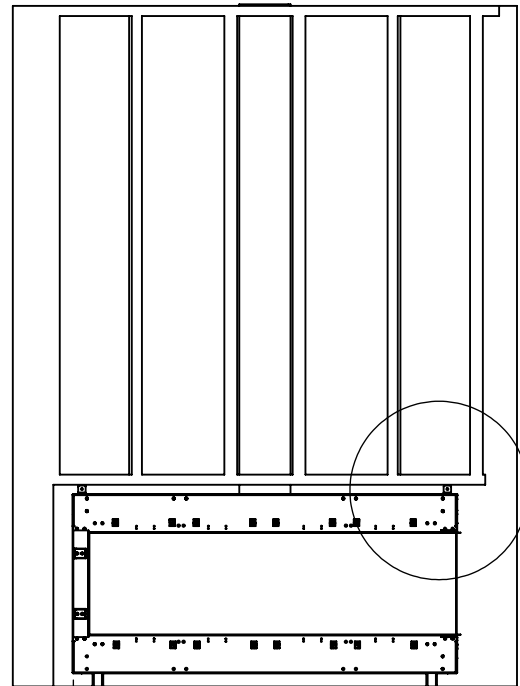

$2\frac{1}{2}"$
63

$2"$
51

$4" \text{ max.}$
 102 max.

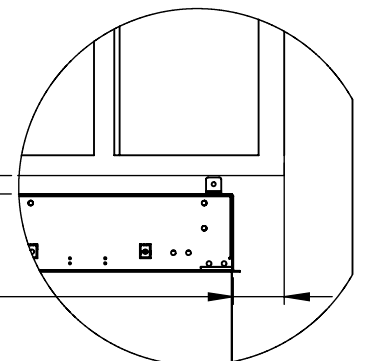

Flat Installation

Last Step - Finishing The Fireplace Wall:

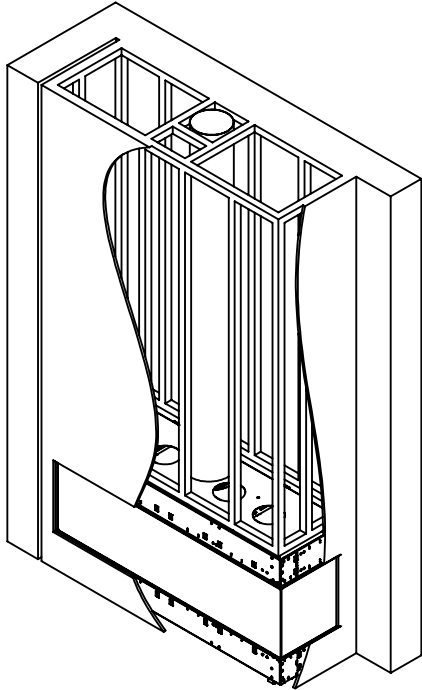

Recess Installation

Step 3 - Framing Front Studs For Recess
After positioning the Fireplace:

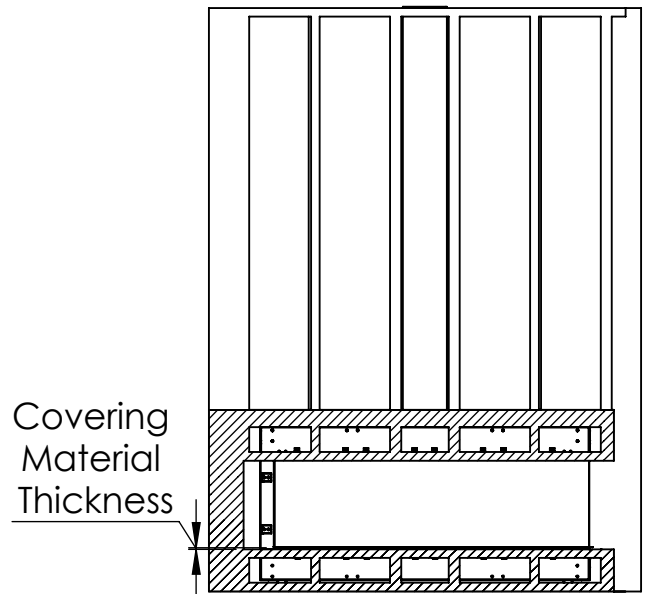

Last Step - Finishing The Fireplace Wall:

