

FLARE See Through 30

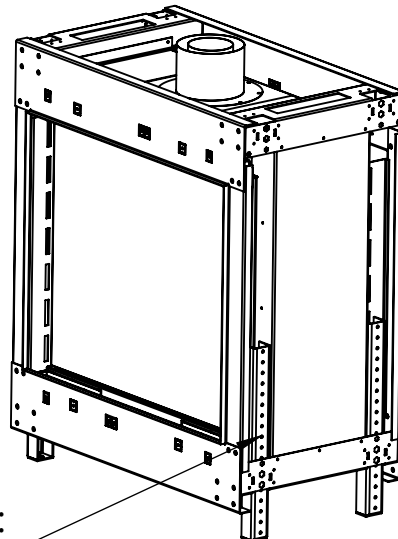

Telescopic Leg Range
(from bottom of glass):
9" - 19"

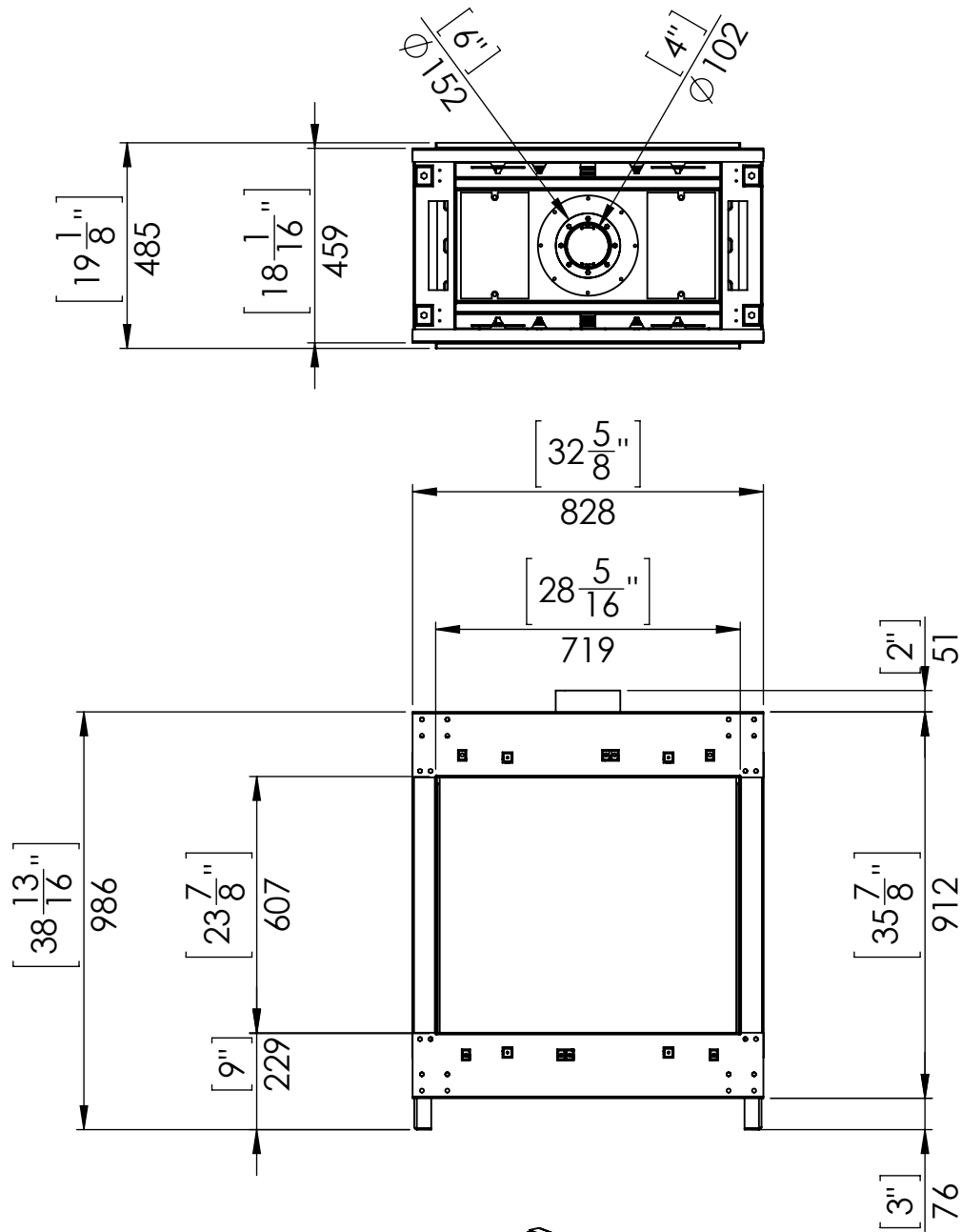
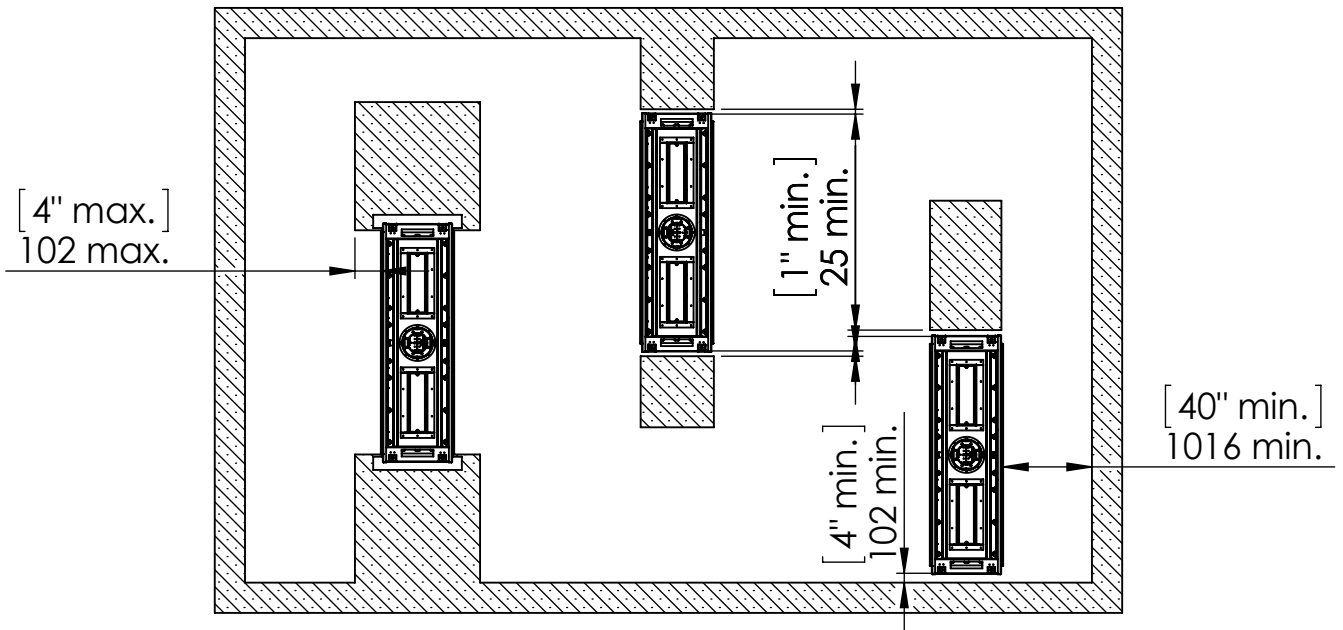

Chimney Installation

Horizontal Termination

For 4 x 6 vent size create 8" x 10" vent termination opening

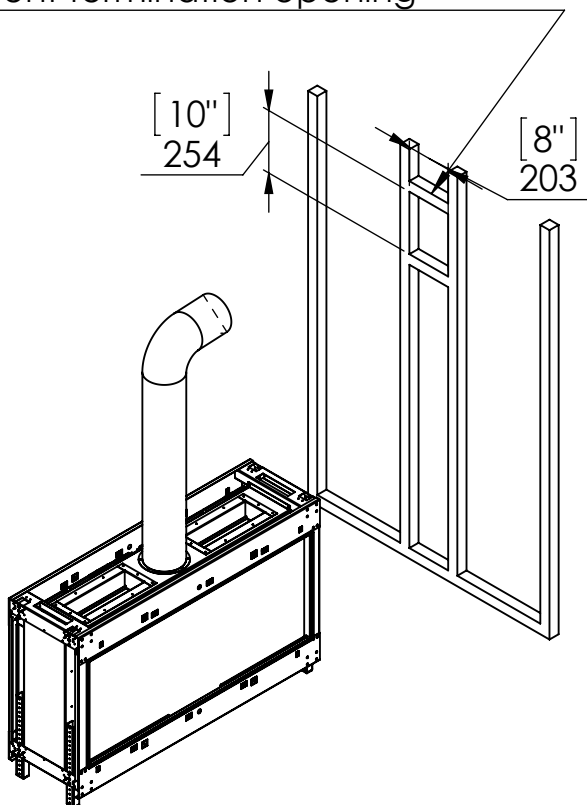

Vertical Termination

For 4 x 6 vent size create 8" x 8" vent termination opening

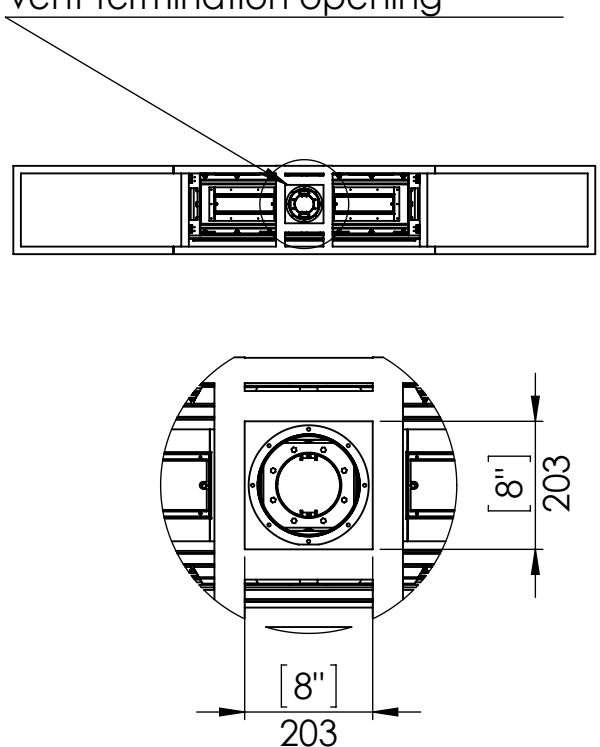

Flat Installation

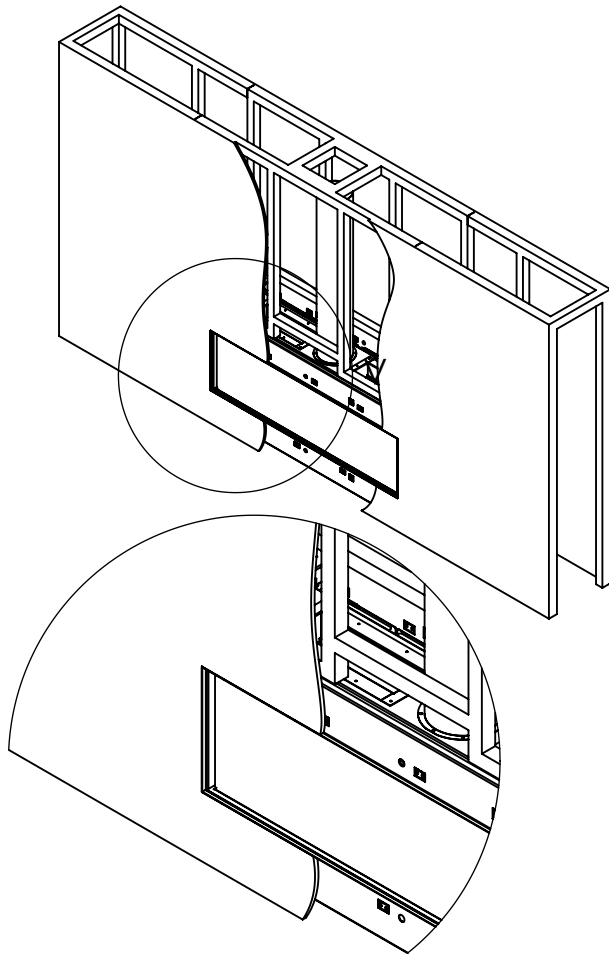

L Shape Installation

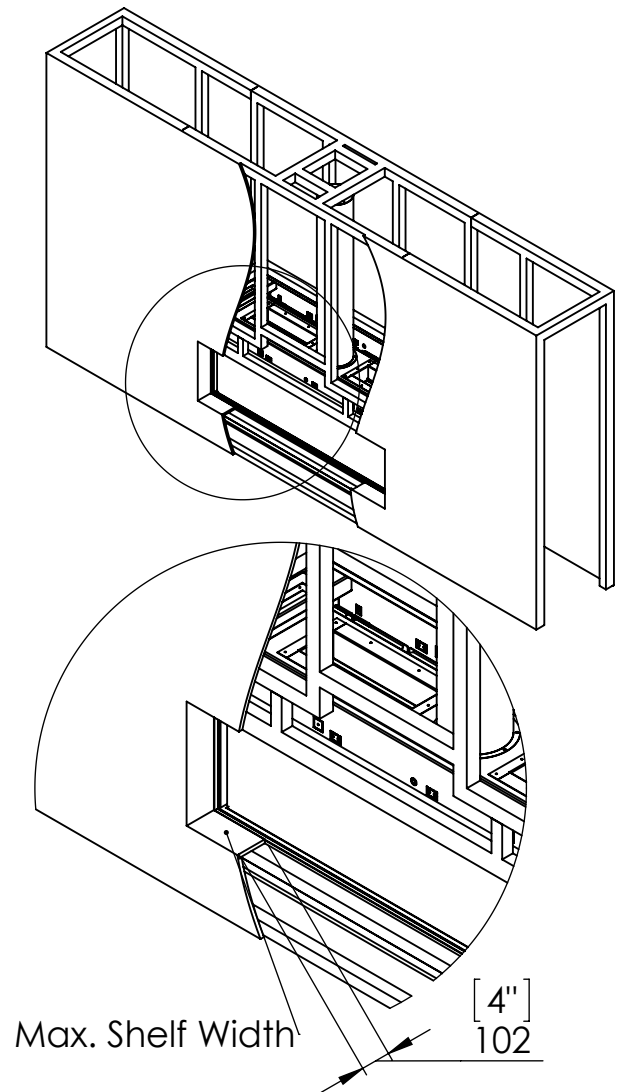

Step 1 - Basic Framing :

Step 1 - Basic Framing :

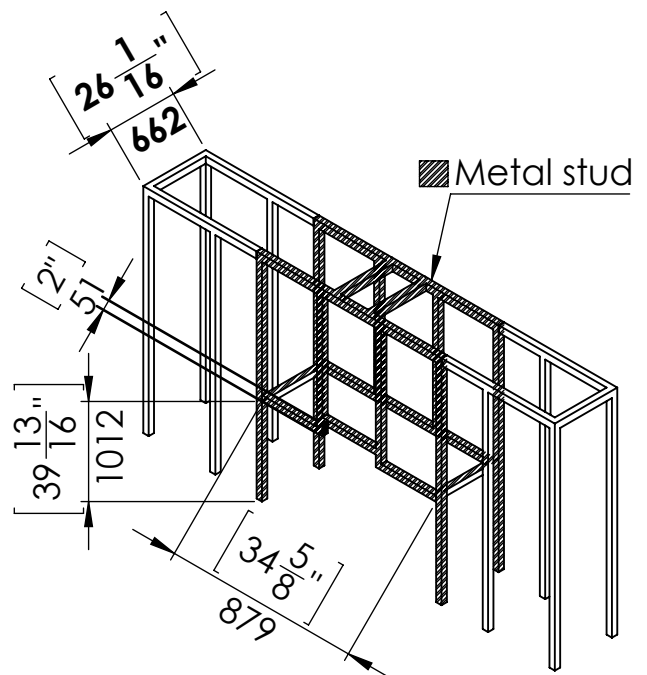
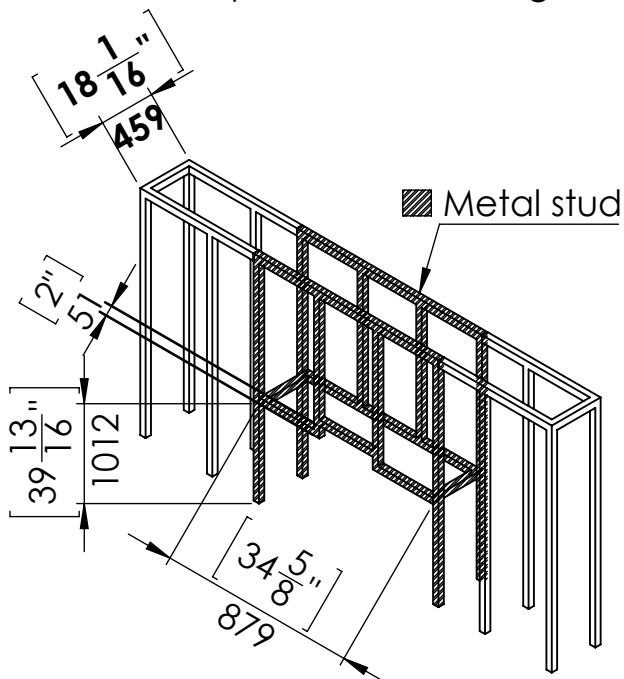

Flat Installation

Step 2 -Positioning the Fireplace:

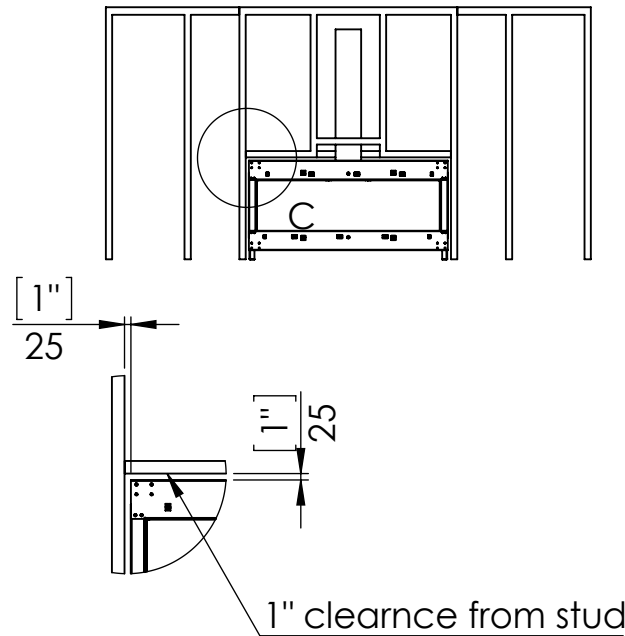
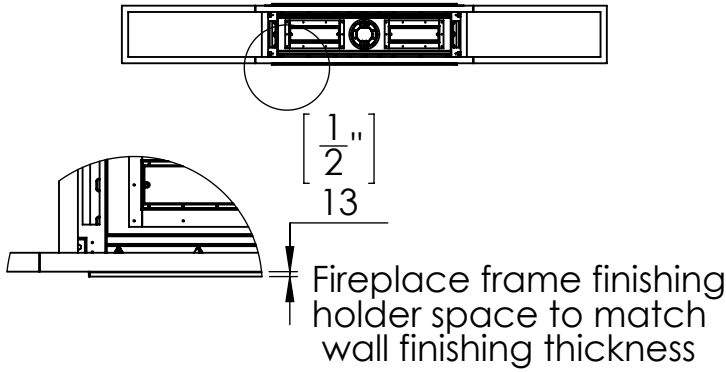

Last Step - Finishing The Fireplace Wall:

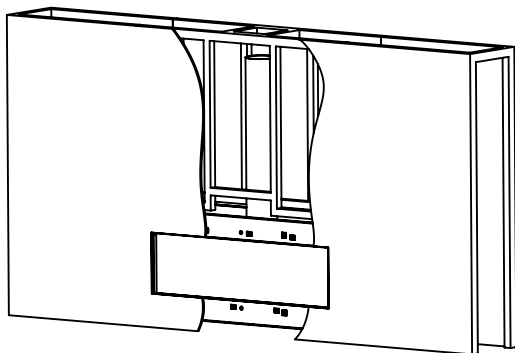

L Shape Installation

Step 2 -Positioning the Fireplace:

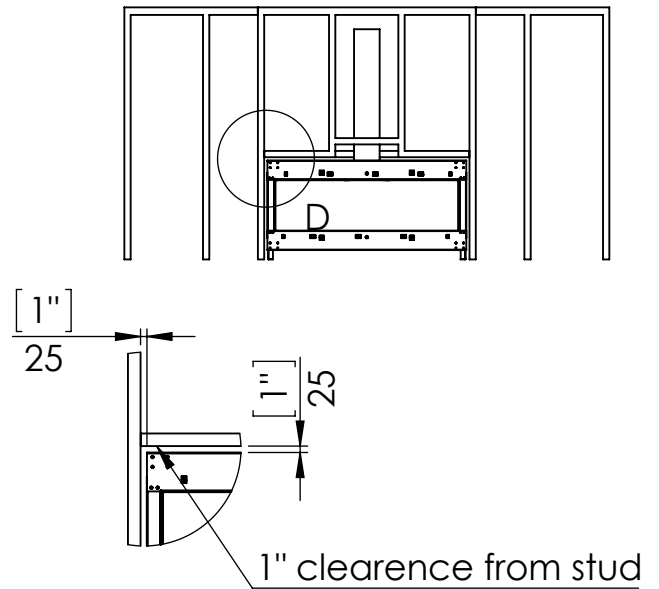
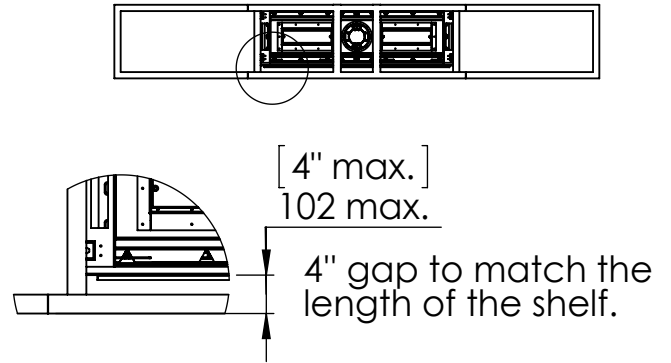

Step 3 - Framing Front Studs For L Shape:

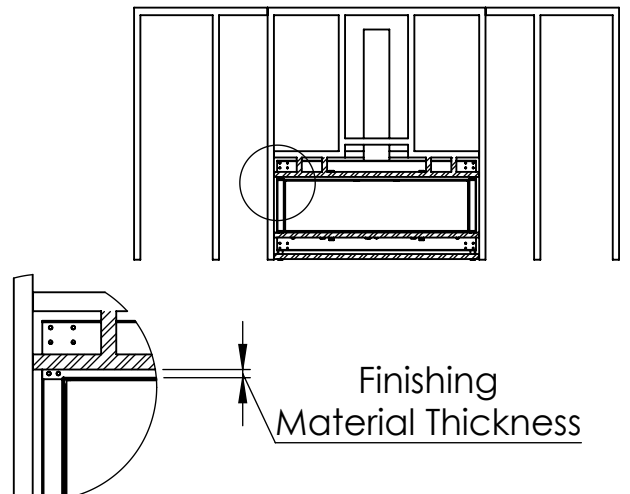

L Shape Finishing Install

Last Step - Finishing The Fireplace Wall:

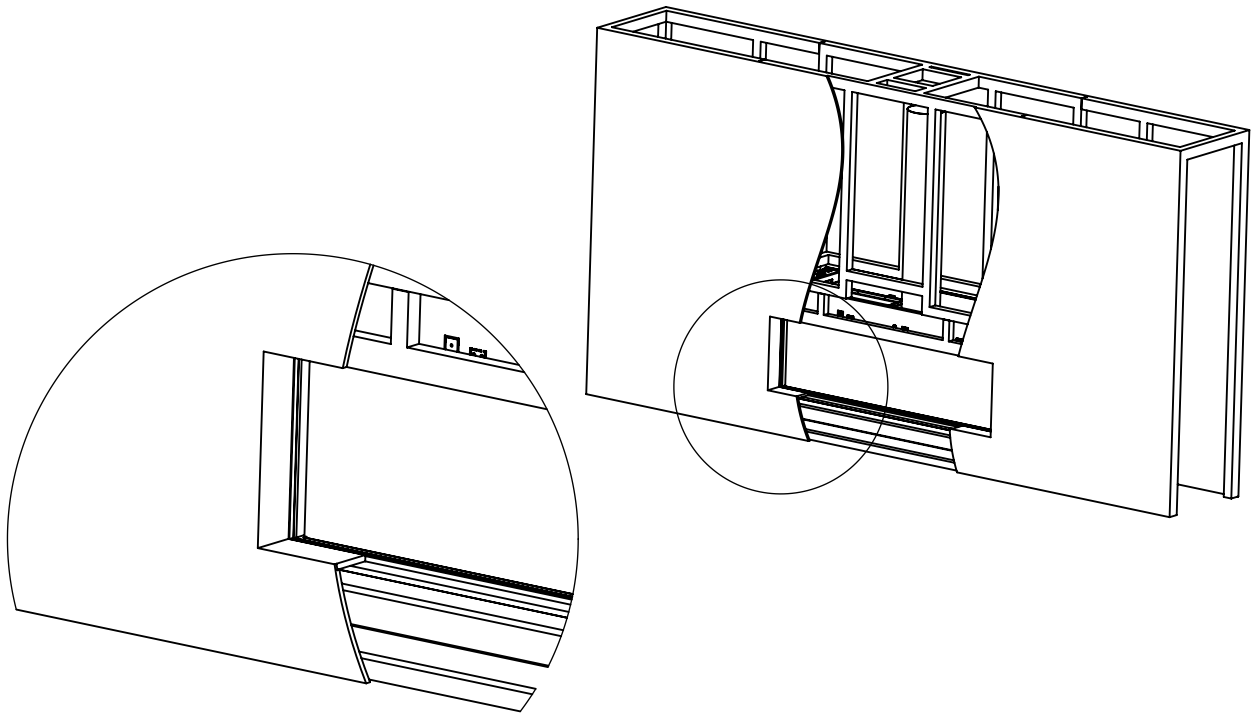

Specifications for Appliance Flare See Through 30

Factor	NG	LPG
Burner Type	55	55
Orifice	650	260
BTU Max.	34000	26200
BTU min.	18500	16000
Kw/h	9.9k	7.6k
Chimney DIA.	4X6	4X6
Manifold Pressure[w.c]	6.4	10.6
Efficiency rate	79	81
Glass Size Length\Width	700 X 620 mm	27" 9/16 X 24" 9/16'
Appliance Weigh	100Kg	220lb